



PRODUTOS DE
TRANSMISSÃO
DE POTÊNCIA

PRODUCTOS DE
TRANSMISIÓN
DE POTENCIA

POWER
TRANSMISSION
PRODUCTS



CORREIAS EM "V"

CORREAS EN "V" / "V" BELTS



MULTI - V

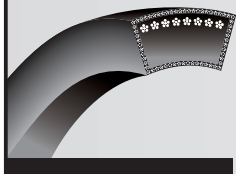

Exemplo / Ejemplo / Example: **B75**

Número de ribs Numero de ribs Number of ribs	Perfil Perfil Profile	Largura da correia Ancho de la correa Top width	Comprimento datum Longitud datum Datum length
1	B	17 mm	76,8"

Construção envelope em todos os tamanhos
 Construcción envelope en todos los tamaños
 Envelope construction for all sizes

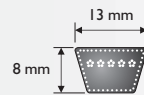

A

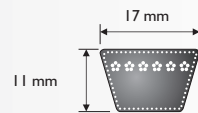

B

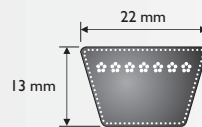

C

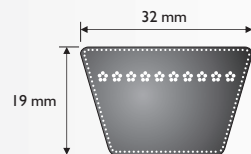

D

CORREIAS EM "V"

CORREAS EN "V" / "V" BELTS

TORQUE FLEX



Exemplo / Ejemplo / Example: **13AX0440**

Número de ribs Numero de ribs Number of ribs	Perfil Perfil Profile	Largura da correia Ancho de la correia Top width	Comprimento datum Longitud datum Datum length
1	13AX	13 mm	0440 mm

Até 118" (inclusive): Construção Cut Edge (X)/Molded Cog
 Acima 118" : Construção envelope lisa
 Hasta 118" (inclusive): Construcción Cut Edge (X)/Molded Cog
 Arriba 118" : Construcción envelope lisa
 Up to 118" (included): Cut Edge (X)/Molded Cog construction
 Above 118" : Smooth envelope construction



HY-T WEDGE



Exemplo / Ejemplo / Example: **3VX 250**

Número de ribs Numero de ribs Number of ribs	Perfil Perfil Profile	Largura da correia Ancho de la correia Top width	Comprimento datum Longitud datum Datum length
1	3V	0,375"	25,0"

Até 118" (inclusive): Construção Cut Edge (X)/Molded Cog
 Acima 118" : Construção envelope lisa
 Hasta 118" (inclusive): Construcción Cut Edge (X)/Molded Cog
 Arriba 118" : Construcción envelope lisa
 Up to 118" (included): Cut Edge (X)/Molded Cog construction
 Above 118" : Smooth envelope construction

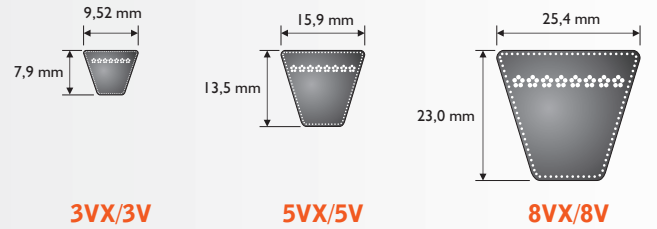

TORQUE TEAM

MULTI - V
HY-T WEDGE
TORQUE FLEX

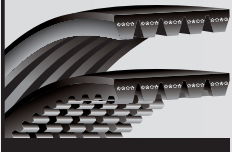

Exemplo / Ejemplo / Example: **3/3VX 400**

Número de ribs Numero de ribs Number of ribs	Perfil Perfil Profile	Largura da correia Ancho de la correia Top width	Comprimento datum Longitud datum Datum length
3	3VX	0,375"	40,0"

Até 118" (inclusive): Construção Cut Edge (X)/Molded Cog
 Acima 118" : Construção envelope lisa
 Hasta 118" (inclusive): Construcción Cut Edge (X)/Molded Cog
 Arriba 118" : Construcción envelope lisa
 Up to 118" (included): Cut Edge (X)/Molded Cog construction
 Above 118" : Smooth envelope construction



FRACIONÁRIAS / FRACCIONÁRIAS / FRACTIONAL



Exemplo / Ejemplo / Example: **ZX 465**

Número de ribs Numero de ribs Number of ribs	Perfil Perfil Profile	Largura da correia Ancho de la correia Top width	Comprimento datum Longitud datum Datum length
1	ZX	9,8 mm	465 mm

Cut Edge/Molded Cog

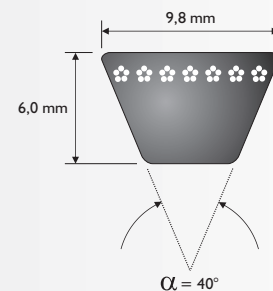

CORREIAS EM "V"

CORREAS EN "V" / "V" BELTS

POLY-V



Exemplo / Ejemplo / Example: **6 PJ 600**

Número de ribs Numero de ribs Number of ribs	Perfil Perfil Profile	Largura da correia Ancho de la correa Top width	Comprimento datum Longitud datum Datum length
6	J	14,04 mm	600 mm

Construção Cut Edge
Construcción Cut Edge
Cut Edge Construction

* Somente sob consulta
* Solamente bajo consulta
* Only on consultation

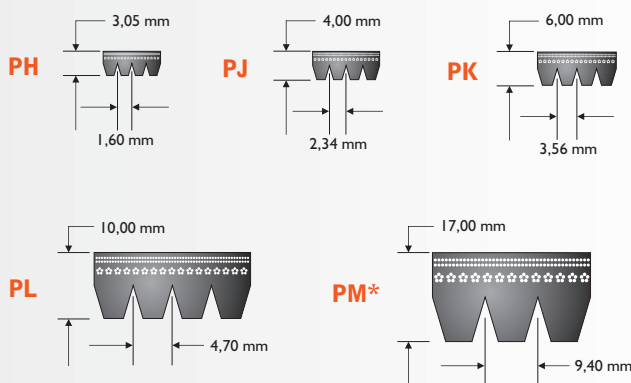

VARIADORAS DE VELOCIDADE INDUSTRIAIS / VARIADORAS DE VELOCIDAD INDUSTRIALES / INDUSTRIAL VARIABLE SPEED

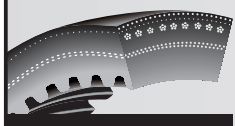

Exemplo / Ejemplo / Example: **3226V585**

Número de ribs Numero de ribs Number of ribs	Perfil Perfil Profile	Largura da correia Ancho de la correa Top width	Comprimento datum Longitud datum Datum length
1	V com 26 graus V con 26 grados V with 26 degrees	50,8 mm	58,5"

Construção Envelope / Cut Edge / Dentes Moldados



Construcción Envelope / CutEdge / Dientes Moldeados



Envelope Construction / Cut Edge / Molded Cog



HEXAGONAIS / HEXAGONALES / HEX

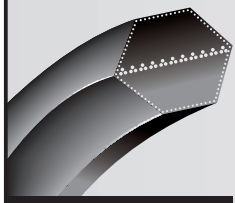

Exemplo / Ejemplo / Example: **BB 75**

Número de ribs Numero de ribs Number of ribs	Perfil Perfil Profile	Largura da correia Ancho de la correa Top width	Comprimento datum Longitud datum Datum length
1	BB	0,66"	75"

Construção envelopada lisa
Construcción capa lisa
Smooth envelope construction

* Somente sob consulta
* Solamente bajo consulta
* Only on consultation

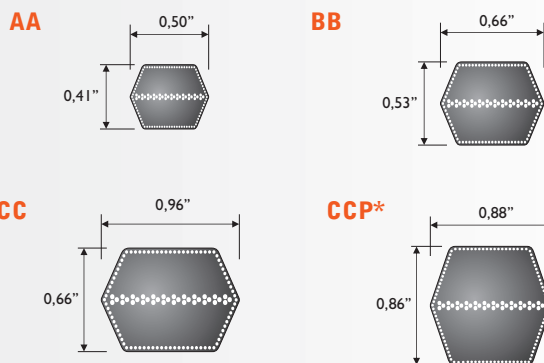

OPEN END

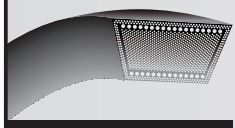

Exemplo / Ejemplo / Example: **B - Open End**

Número de ribs Numero de ribs Number of ribs	Perfil Perfil Profile	Largura da correia Ancho de la correa Top width	Comprimento datum Longitud datum Datum length
1	B	0,66"	Rolos 76 m (250') Rollos 76 m (250') Reels 76 m (250')

Construção envelopada lisa
Construcción capa lisa
Smooth envelope construction

* Somente sob consulta
* Solamente bajo consulta
* Only on consultation

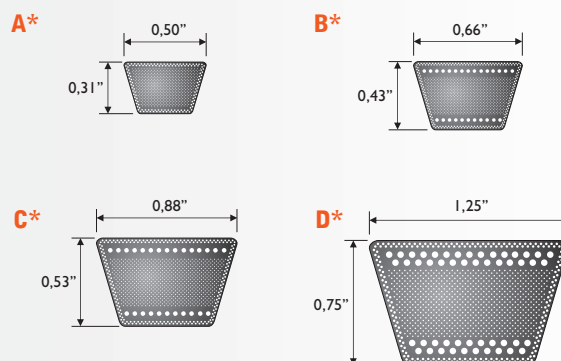

CORREIAS SINCRONIZADORAS

CORREAS SINCRÓNICAS / SYNCHRONOUS BELTS



POSITIVE DRIVE

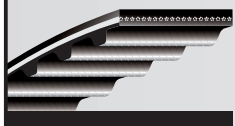

Exemplo / Ejemplo / Example: **100 XL 025**

Passo Paso Pitch	Perfil Perfil Profile	Largura da correia Ancho de la correa Top width	Comprimento datum Longitud datum Datum length
0,200"	XL	025=0,25"	100=10,0"

Construção enrolada todos os tamanhos
 Construcción capa todos los tamaños
 Envelope construction all sizes

* Somente sob consulta
 * Solamente bajo consulta
 * Only on consultation

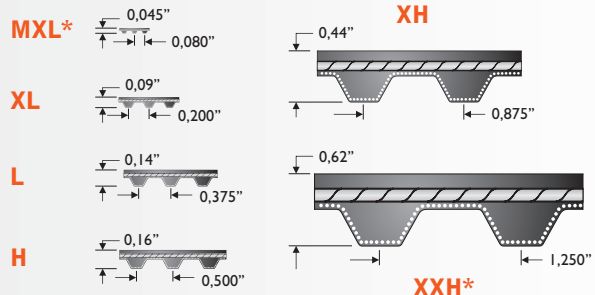

CORREIAS SINCRONIZADORAS

CORREAS SINCRÓNICAS / SYNCHRONOUS BELTS

HAWK PD

Exemplo / Ejemplo / Example: **800 8M 50**

Passo Paso Pitch	Perfil Perfil Profile	Largura da correia Ancho de la correa Top width	Comprimento datum Longitud datum Datum length
8 mm	8M	50=50 mm	800=800 mm

5M

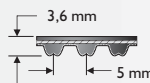

8M

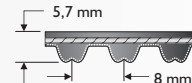

14M

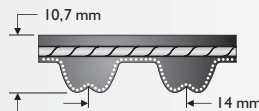

20M*

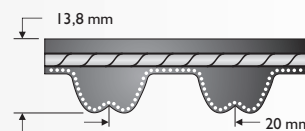

* Somente sob consulta
* Solamente bajo consulta
* Only on consultation

DUAL POSITIVE DRIVE

Exemplo / Ejemplo / Example: **D 225 L 050**

Passo Paso Pitch	Perfil Perfil Profile	Largura da correia Ancho de la correa Top width	Comprimento datum Longitud datum Datum length
0,200"	L	050=0,50"	225=22,5"

Dentes em ambos os lados
Dientes en los dos lados
Teeth in both side

XL

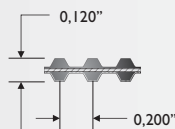

L

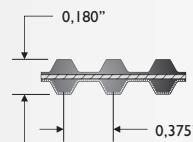

H

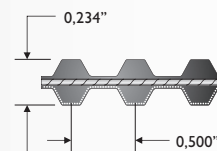

DUAL HI-PERFORMANCE

Exemplo / Ejemplo / Example: **D1040 8M 20**

Passo Paso Pitch	Perfil Perfil Profile	Largura da correia Ancho de la correa Top width	Comprimento datum Longitud datum Datum length
8 mm	8M	20=20 mm	1040=1040 mm

Dentes em ambos os lados
Dientes en los dos lados
Teeth in both side

8M

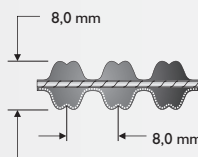

14M

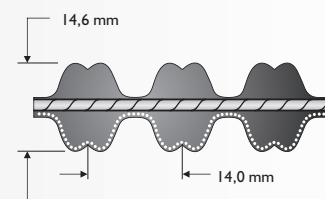

SUPER TORQUE PD

Exemplo / Ejemplo / Example: **100 S5M 375**

Passo Paso Pitch	Perfil Perfil Profile	Largura da correia Ancho de la correa Top width	Comprimento datum Longitud datum Datum length
5 mm	S5M	100=10,0 mm	375=375 mm

S5M*

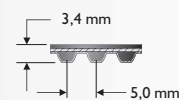

S8M

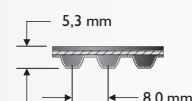

S14M

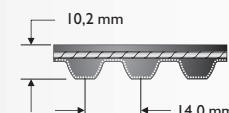

* Somente sob consulta
* Solamente bajo consulta
* Only on consultation

CORREIAS SINCRONIZADORAS

CORREAS SINCRÓNICAS / SYNCHRONOUS BELTS

FALCON PD

Exemplo / Ejemplo / Example: **8GTR-640-12**

Passo Paso Pitch	Perfil Perfil Profile	Largura da correia Ancho de la correa Top width	Comprimento datum Longitud datum Datum length
8 = 8 mm	GTR	12 = 12,0 mm	640 = 640 mm

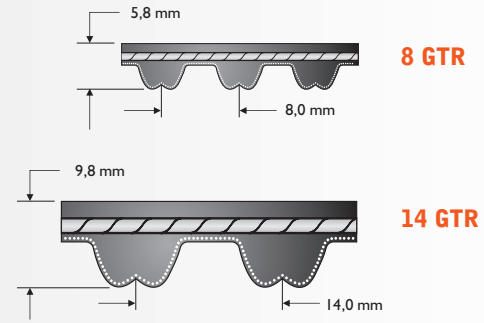

BLACK HAWK PD

Exemplo / Ejemplo / Example: **2310 14BH 115**

Passo Paso Pitch	Perfil Perfil Profile	Largura da correia Ancho de la correa Top width	Comprimento datum Longitud datum Datum length
14 mm	BH=Black Hawk	115 = 115,0 mm	2310 = 2310 mm

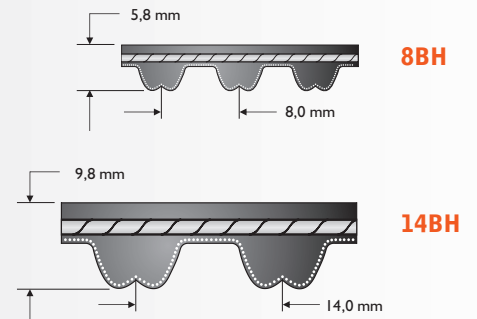

EAGLE PD

Exemplo / Ejemplo / Example: **Y-640**

Cor Color Colour	Passo Paso Pitch	Perfil Perfil Profile	Largura da correia Ancho de la correa Top width	Comprimento datum Longitud datum Datum length
Yellow	8 mm	Y	16 mm	640 mm
Yellow	8 mm	Y	16 mm	640 mm / 2400 mm
White	8 mm	W	32 mm	640 mm / 2400 mm
Purple	8 mm	P	64 mm	720 mm / 1600 mm
Blue	14 mm	B	35 mm	994 mm / 3920 mm
Green	14 mm	G	52 mm	994 mm / 3920 mm
Orange	14 mm	O	70 mm	1120 mm / 3920 mm
Red	14 mm	R	105 mm	1260 mm / 3920 mm

Construção especial
Construcción especial
Special construction

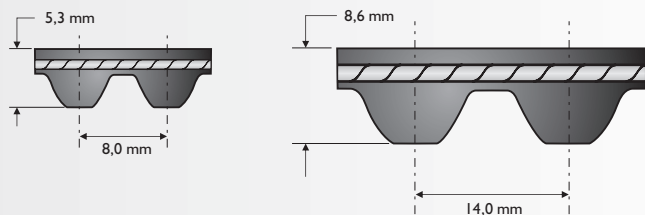

CORREIAS DE POLIURETANO

CORREAS DE POLIURETANO / POLYURETHANE BELTS



PERFIL T / PERFIL T / T PROFILE

Exemplo / Ejemplo / Example: **25 T10 500**

Passo Paso Pitch	Perfil Perfil Profile	Largura da correia Ancho de la correa Top width	Comprimento datum Longitud datum Datum length
10 mm	T10	25=25 mm	500=500 mm

* Somente sob consulta
* Solamente bajo consulta
* Only on consultation

Largura das correias Ancho de la correas Top width			
T2,5	T5	T10*	T20*
4	10	10	25
6	16	16	32
10	25	25	50
20	32	32	75
50	50	50	100
100	75	75	*150
	100	100	*200

T2,5

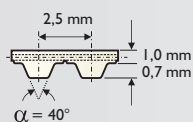

T5

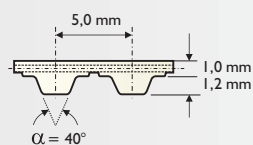

T10*

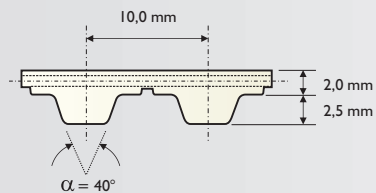

T20*

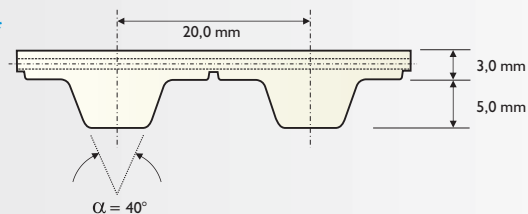

CORREIAS DE POLIURETANO

PERFIL AT / PERFIL AT / AT PROFILE

Exemplo / Ejemplo / Example: 32 AT10 550

Passo Paso Pitch	Perfil Perfil Profile	Largura da correia Ancho de la correa Top width	Comprimento datum Longitud datum Datum length
10 mm	AT10	32=32 mm	550=550 mm

* Somente sob consulta
* Solamente bajo consulta
* Only on consultation

Largura das correias Ancho de la correas Top width		
AT5	AT10	AT20
10	16	25
16	25	32
25	32	50
32	50	75
50	75	100
75	100	*150
100	*150	

AT5

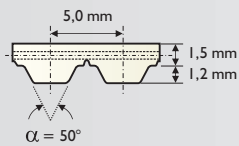

AT10*

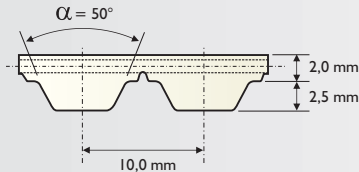

AT20*

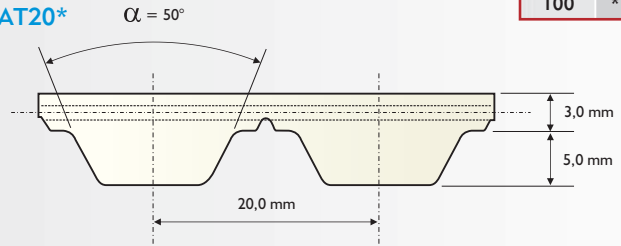

PERFIL EM POLEGADA / PERFIL EN PULGADA / INCH PROFILE

Exemplo / Ejemplo / Example: 1500 H 100

Passo Paso Pitch	Perfil Perfil Profile	Largura da correia Ancho de la correa Top width	Comprimento datum Longitud datum Datum length
12,7 mm	H	100=1,00"	1500=150"

* Somente sob consulta
* Solamente bajo consulta
* Only on consultation

Largura das correias Ancho de la correas Top width			
L	H	XL	XH
050	050	025	100
075	075	031	200
100	100	037	300
150	150	050	400
200	200	075	*600
300	300	100	
400	400	150	
	*600	200	
	*800	400	

L

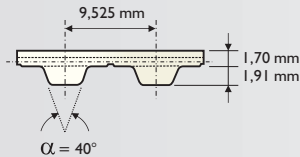

H*

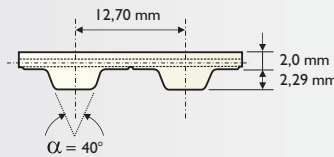

XL

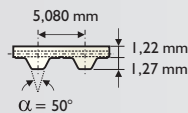

XH*

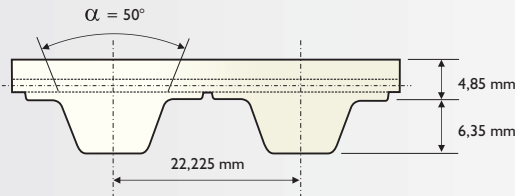

PERFIL HTD / PERFIL HTD / HTD PROFILE

Exemplo / Ejemplo / Example: 50 5M 1250

Passo Paso Pitch	Perfil Perfil Profile	Largura da correia Ancho de la correa Top width	Comprimento datum Longitud datum Datum length
5 mm	5M	50=50 mm	1250=1250 mm

* Somente sob consulta
* Solamente bajo consulta
* Only on consultation

Largura das correias Ancho de la correas Top width			
HTD 3	HTD 5	HTD 8	HTD14
10	10	10	25
15	15	15	40
25	25	20	55
50	50	30	85
100	100	50	*115
		85	*150
		100	

HTD 3M

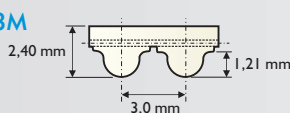

HTD 5M

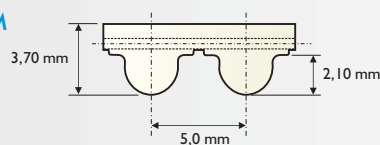

HTD 8M

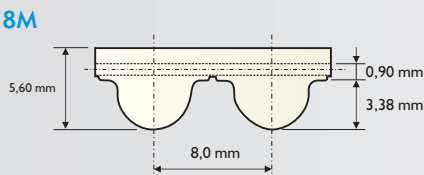

HTD 14M*

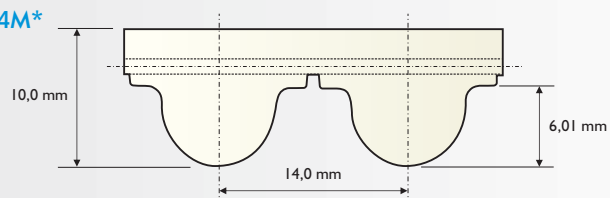

CORREIAS DE POLIURETANO

CORREAS DE POLIURETANO / POLYURETHANE BELTS

PERFIL RPP / PERFIL RPP / RPP PROFILE

Exemplo / Ejemplo / Example: 30 RPP8 1440

Passo Paso Pitch	Perfil Perfil Profile	Largura da correia Ancho de la correa Top width	Comprimento datum Longitud datum Datum length
8 mm	RPP8	30=30 mm	1440=1440 mm

* Somente sob consulta
* Solamente bajo consulta
* Only on consultation

Largura das correias Ancho de la correas Top width		
RPP5	RPP8	RPP14
10	10	40
15	15	55
25	20	85
30	30	*115
50	50	
100	85	
	100	

RPP 5M

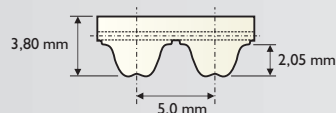

RPP 8M

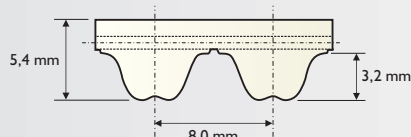

RPP 14M*

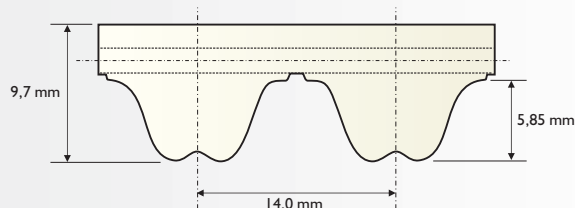

SUPER TORQUE PD

* Somente sob consulta
* Solamente bajo consulta
* Only on consultation

Largura das correias Ancho de la correas Top width		
STD5	STD8	STD14
10	10	40
15	15	55
25	20	85
50	30	*115
100	50	
	85	
	100	

STD 5M

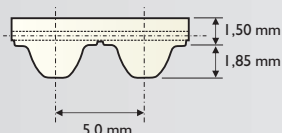

STD 8M

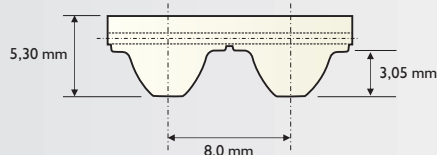

STD 14M

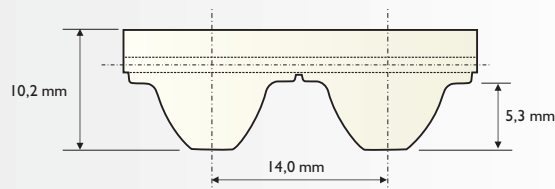

PERFIL EAGLE / PERFIL EAGLE / EAGLE PROFILE

Exemplo / Ejemplo / Example: L8 1440

Passo Paso Pitch	Perfil Perfil Profile	Largura da correia Ancho de la correa Top width	Comprimento datum Longitud datum Datum length
8 mm	L8	50=50 mm	1440=1440 mm

Cor Color Colour	Passo Paso Pitch	Perfil Perfil Profile	Largura da correia Ancho de la correa Top width
Yellow	8 mm	Y	16,0 mm
Maroon	8 mm	M	25,0 mm
White	8 mm	W	32,0 mm
Lime	8 mm	L	50,0 mm
Blue	14 mm	B	35,0 mm
Aquamarine	14 mm	A	52,5 mm
Orange	14 mm	O	70,0 mm
Red	14 mm	R	*105,0 mm

Eagle 8M

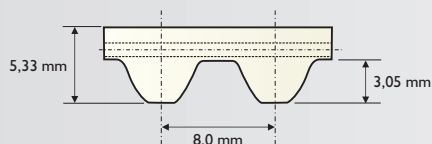

Eagle 14M*

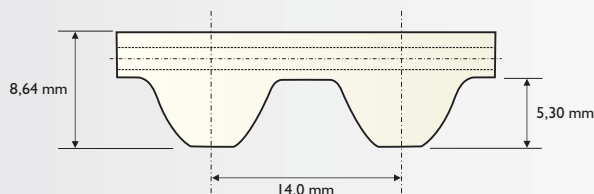

* Somente sob consulta
* Solamente bajo consulta
* Only on consultation

CORREIAS DE POLIURETANO

CORREAS DE POLIURETANO / POLYURETHANE BELTS

PERFIS TK E ATK / PERFILES AT Y ATK / AT AND ATK PROFILES

Exemplo / Ejemplo / Example: **32 ATK10 1650**

Passo Paso Pitch	Perfil Perfil Profile	Largura da correia Ancho de la correa Top width	Comprimento datum Longitud datum Datum length
10 mm	ATK10	32=32 mm	1650=1650 mm

* Somente sob consulta
* Solamente bajo consulta
* Only on consultation

Largura das correias Ancho de la correas Top width			
TK5	TK10	ATK5	ATK10
32	32	32	32
50	50	50	50
75	75	75	75
100	100	100	100
			*150

TK5

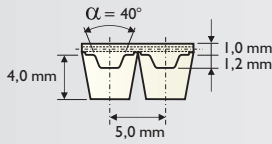

TK10

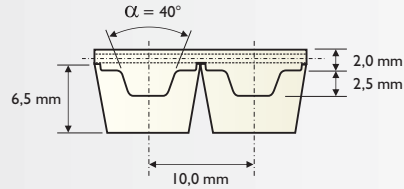

ATK5

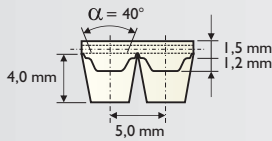

ATK10*

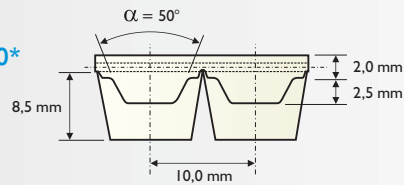

ESPECIAIS / ESPECIALES / SPECIALS

Exemplo / Ejemplo / Example: **10 TT510500**

Passo Paso Pitch	Perfil Perfil Profile	Largura da correia Ancho de la correa Top width	Comprimento datum Longitud datum Datum length
5 mm	TT5	10=100 mm	10500=10500 mm

Largura das correias Ancho de la correas Top width	
TT5	T10 TP
10	10
	16
	25
	32
	50
	60
	80
	90
	100

TT5

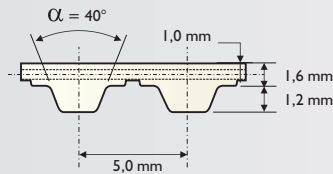

T10 TP (Total Protection)

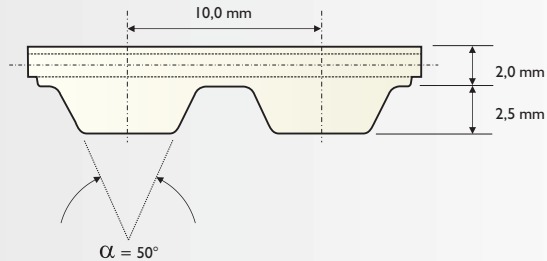

PERFIL FLAT / PERFIL FLAT / FLAT PROFILE

Exemplo / Ejemplo / Example: **30 F1 5000**

Passo Paso Pitch	Largura da correia Ancho de la correa Top width	Comprimento datum Longitud datum Datum length
F1	30=30 mm	5000=5000 mm

* Somente sob consulta
* Solamente bajo consulta
* Only on consultation

Largura das correias Ancho de la correas Top width			
F1	F2	F 2,5	F3
10	10	25	10
15	20	30	25
25	30	60	50
30	40	*120	75
50	50		100
75	100		*120
100			

F1



F2,5*



F2

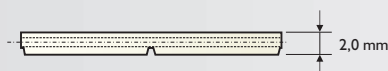

F3*



Argentina

Av. Cabildo, 2677 - 4º Piso
 (1428) Capital Federal
 Buenos Aires - Argentina
 Tel: (54-11) 4896-1211
 Fax: (54-11) 4896-1666

Brasil

Rodovia Castelo Branco 11370
 Cep: 06421-400 - Barueri - SP
 0800 55 49 14
 e-mail: pe.industrial@veyance.com

Chile

Camino a Melipilla Km16
 Casilla 3607 - Santiago - Chile
 Tel: (56-2) 5301336
 Fax: (56-2) 5301345

México

Eje 128 N° 140 interior A y B
 Zona Industrial - CP78090
 San Luis Potosi

Venezuela

Carretera Nacional Tinaquillo-Valencia
 Km 46 - Tinaquillo - Cojedes
 Tel: (58-258) 430-0032
 Fax: (58-258) 430-0055



Distribuidor/Distribuidor/Distributor

The GOODYEAR (and Winged Foot Design) trademark is used by Veyance Technologies, Inc. under license from The Goodyear Tire & Rubber Company. Goodyear Engineered Products are manufactured and sourced exclusively by Veyance ©2008 Veyance Technologies, Inc. All Rights Reserved