

CAIXA	d1 mm / pol eixo ¾	D H7	a	b	c	g H12	h H12	L	w	m	S	u	v	x
SNA 505	20	52	165	46	19	25	40	67	74	130	M12	15	20	20
SNA 506	25	62	185	52	22	32	50	77	90	150	M12	15	20	21
SNA 507	30	72	185	52	22	34	50	82	95	150	M12	15	20	23
SNA 508	35	80	205	60	25	39	60	85	110	170	M12	15	20	24
SNA 509	40	85	205	60	25	30	60	85	110	170	M12	15	20	25
SNA 510	45	90	205	60	25	41	60	90	115	170	M12	15	20	26
SNA 511	50	100	255	70	28	44	70	95	130	210	M16	18	23	28
SNA 512	55	110	255	70	30	48	70	105	135	210	M16	18	23	30
SNA 513	60	120	275	80	30	51	80	110	150	230	M16	18	23	33
SNA 514	60	125	275	80	30	51	80	115	155	230	M16	18	23	
SNA 515	65	130	280	80	30	56	80	115	155	230	M16	18	23	34
SNA 516	70	140	315	90	32	58	95	120	175	260	M20	22	27	38
SNA 517	75	150	320	90	32	61	95	125	185	260	M20	22	27	40
SNA 518	80	160	345	100	35	65	100	140	195	290	M20	22	27	42
SNA 519	85	170	345	100	35	68	112	145	210	290	M20	22	27	45
SNA 520	90	180	380	110	40	70	112	160	215	320	M24	26	32	48
SNA 522	100	200	410	120	45	80	125	175	240	350	M24	26	32	53
SNA 524	110	215	410	120	45	86	140	185	271	350	M24	26	32	56
SNA 526	115	230	445	130	50	90	150	190	290	380	M24	28	35	60
SNA 528	125	250	500	150	50	98	150	205	302	420	M30	35	42	63
SNA 530	135	270	530	160	60	106	160	220	323	450	M30	35	42	68
SNA 532	140	290	550	160	60	114	170	235	344	470	M30	35	42	73

Obs: Os anéis de guia (FRB) e tampas A x DK, não são fornecidas. As mesmas devem ser encomendadas separadamente. Será colocado graxadeiras quando solicitado.

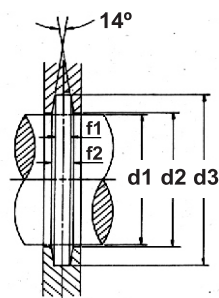

d1 H12	d2 H12	d3 H12	f1 H13	f2	ROLAMENTOS	BUCHAS CÔNICAS	FRB	FELTROS	A-DK
20	21.5	31.5	5	5.4	1205K 2205K	H 205 H 305	2 FRB 52/5 2 FRB 52/3.5	5X4-40 / 4	31
25	26.5	36.5	5	5.4	1206K 2206K 22206K	H 206 H 306 H 306	2 FRB 62/8 2 FRB 62/6 2 FRB 62/6	6X5-55 / 4	36
30	31.5	41.5	5	5.4	1207K 2207K 22207K	H 207 H 307 H 307	2 FRB 72/8.5 2 FRB 72/5.5 2 FRB 72/5.5	6X5-60 / 4	41
35	36.5	46.5	5	5.4	1208K 2208K 22208K	H 208 H 308 H 308	2 FRB 80/10.5 2 FRB 80/8 2 FRB 80/8	6X5-70 / 4	46
40	41.5	51.5	5	5.4	1209K 2209K 22209K	H 209 H 309 H 309	2 FRB 85/5.5 2 FRB 85/3.5 2 FRB 85/3.5	6X5-75 / 4	51
45	46.5	56.5	5	5.4	1210K 2210K 22210K	H 210 H 310 H 310	2 FRB 90/10.5 2 FRB 90/9 2 FRB 90/9	6X5-85 / 4	56
50	51.5	61.5	5	6.9	1211K 2211K 22211K	H 211 H 311 H 311	2 FRB 100/11.5 2 FRB 100/9.5 2 FRB 100/9.5	8X6.5-100 / 4	61
55	56.5	66.5	5	6.9	1212K 2212K 22212K	H 212 H 312 H 312	2 FRB 110/13 2 FRB 110/10 2 FRB 110/10	8X6.5-105 / 4	66
60	62	72	5	6.9	1213K 2213K 22213K	H 213 H 313 H 313	2 FRB 120/14 2 FRB 120/10 2 FRB 120/10	8X6.5-115 / 4	71.5
60	62	72	5	6.9	1214K 2214K 22214K	H 214 H 314 H 314	2 FRB 125/10 2 FRB 125/6.5 2 FRB 125/6.5	8X6.5-115 / 4	71.5
65	67	77	5	6.9	1215K 2215K 22215K	H 215 H 315 H 315	2 FRB 130/15.5 2 FRB 130/12.5 2 FRB 130/12.5	8X6.5-120 / 4	76.5
70	72	82	5	8.1	1216K 2216K 22216K	H 216 H 316 H 316	2 FRB 140/16 2 FRB 140/12.5 2 FRB 140/12.5	9X7.5-130 / 4	81.5
75	77	87	5	8.1	1217K 2217K 22217K	H 217 H 317 H 317	2 FRB 150/16.5 2 FRB 150/12.5 2 FRB 150/12.5	9X7.5-140 / 4	86.5
80	82	92	5	8.1	1218K 2218K 22218K 23218K	H 218 H 318 H 318 H 2318	2 FRB 160/17.5 2 FRB 160/12.5 2 FRB 160/12.5 2 FRB 160/6.25	9X7.5-150 / 4	91.5
85	87	97	6	8.1	1219K 2219K 22219K	H 219 H 319 H 319	2 FRB 170/18 2 FRB 170/12.5 2 FRB 170/12.5	9X7.5-155 / 4	96.5
90	92	102	6	10.8	1220K 2220K 22220K 23220K	H 220 H 320 H 320 H 320	2 FRB 180/18 2 FRB 180/12 2 FRB 180/12 2 FRB 180/4.85	10X8.5-165 / 4	101.5
100	102	112	6	10.8	1222K 2222K 22222K 23222K	H 222 H 322 H 322 H 2322	2 FRB 200/21 2 FRB 200/13.5 2 FRB 200/13.5 2 FRB 200/5.1	12X10-185 / 4	111.5
110	113	123	6	10.7	22224K 23224K	H 3124 H 2324	2 FRB 215/14 2 FRB 215/5	12X10-200 / 4	122.5
115	118	128	6	10.7	22226K 23226K	H 3126 H 2326	2 FRB 230/13 2 FRB 230/5	12X10-200 / 4	127.5
125	128	138	6	12.2	22228K 23228K	H 3128 H 2328	2 FRB 250/15 2 FRB 250/5	14X11-245 / 4	137.5
135	138	148	6	12.2	22230K 23230K	H 3130 H 2330	2 FRB 270/16.5 2 FRB 270/5	16X12-260 / 4	147.5
140	143	153	6	12.2	22232K 23232K	H 3132 H 2332	2 FRB 290/17 2 FRB 290/5	16X12-260 / 4	152.5

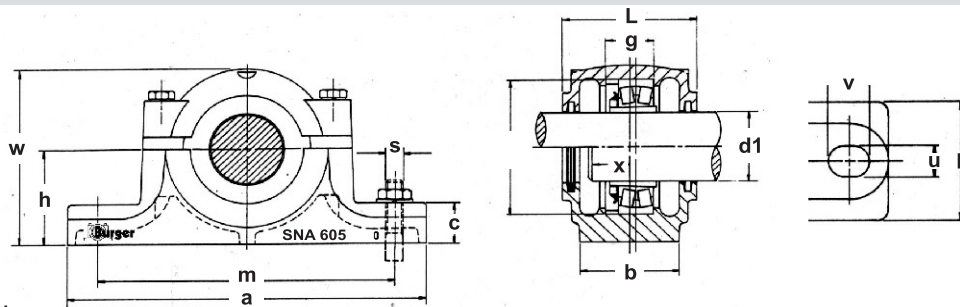

CAIXA	d1 mm / pol	D H7	a	b	c	g	h H12	L	w	m	S	u	v	X
SNA 605	20 ^{eixo} _¼	62	185	52	22	32	50	77	90	150	M12	15	20	19
SNA 606	25 1"	72	185	52	22	34	50	82	95	150	M12	15	20	20
SNA 607	30 1. 1/8"	80	205	60	25	39	60	85	110	170	M12	15	20	28
SNA 608	35 1. 1/4"	90	205	60	25	41	60	90	115	170	M12	15	20	30
SNA 609	40 1. ½"	100	255	70	28	44	70	95	130	210	M16	18	23	33
SNA 610	45 1. ¾"	110	255	70	30	48	70	105	135	210	M16	18	23	35
SNA 611	50 2"	120	275	80	30	51	80	110	150	230	M16	18	23	37
SNA 612	55 2. 1/8"	130	280	80	30	56	80	115	155	230	M16	18	23	39
SNA 613	60 2. 1/4"	140	315	90	32	58	95	120	175	260	M20	22	27	41
SNA 614	60 -	150	320	90	32	61	95	125	185	260	M20	22	27	-
SNA 615	65 2. ½"	160	345	100	35	65	100	140	195	290	M20	22	27	46
SNA 616	70 2. ¾"	170	345	100	35	68	112	145	210	290	M20	22	27	50
SNA 617	75 3"	180	380	110	40	70	112	160	215	320	M24	26	32	52
SNA 618	80 3. 1/4"	190	380	110	40	74	112	160	220	320	M24	26	32	54
SNA 619	85 -	200	410	120	45	80	125	175	240	350	M24	26	32	57
SNA 620	90 3. ½"	215	410	120	45	86	140	185	271	350	M24	26	32	61
SNA 622	100 4"	240	450	130	50	90	150	185	298	390	M24	28	35	66
SNA 624	110 4. 1/4"	260	530	160	60	98	160	190	321	450	M30	35	42	70
SNA 626	115 4. ½"	280	550	160	60	106	170	205	344	470	M30	35	42	75
SNA 628	125 5"	300	620	170	65	114	180	215	366	520	M30	35	42	80
SNA 630	135 5. 1/4"	320	650	180	65	118	190	225	386	560	M30	35	42	85
SNA 632	140 5. ½"	340	680	190	70	124	200	235	406	580	M36	42	50	90

Obs: Os anéis de guia (FRB) e tampas A x DK, não são fornecidas. As mesmas devem ser encomendadas separadamente. Será colocado engraxadeiras quando solicitado.

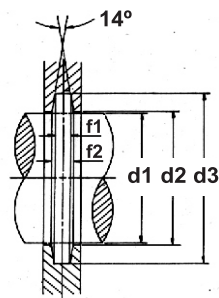

d1 H12	d2 H12	d3 H12	f1 H13	f2	ROLAMENTOS	BUCHAS CÔNICAS	ANÉIS DE BLOQUEIO	FELTROS	A - DK
20	21	31	5	5.4	1305K 2305K	H 305 H 2305	2 FRB 62/7.5 2 FRB 62/4	5X4-40/4	30.5
25	26	36	5	5.4	1306K 2306K	H 306 H 2306	2 FRB 72/7.5 2 FRB 72/3.5	6X5-55/4	35.5
30	31	41	5	5.4	1307K 2307K	H 307 H 2307	2 FRB 80/9 2 FRB 80/4	6X5-60/4	40.5
35	36	46	5	5.4	1308K 2308K 21308CCK 22308K	H 308 H 2308 H 308 H 2308	2 FRB 90/9 2 FRB 90/4 2 FRB 90/9 2 FRB 90/4	6X5-70/4	45.5
40	41	51	5	5.4	1309K 2309K 21309CCK 22309K	H 309 H 2309 H 309 H 2309	2 FRB 100/9.5 2 FRB 100/4 2 FRB 100/9.5 2 FRB 100/4	6X5-75/4	50.5
45	46	56	5	5.4	1310K 2310K 21310CCK 22310K	H 310 H 2310 H 310 H 2310	2 FRB 110/10.5 2 FRB 110/4 2 FRB 110/10.5 2 FRB 110/4	6X5-85/4	55.5
50	52	62	5	6.9	1311K 2311K 21311CCK 22311K	H 311 H 2311 H 311 H 2311	2 FRB 120/11 2 FRB 120/4 2 FRB 120/11 2 FRB 120/4	8X6.5-100/4	61.5
55	57	67	5	6.9	1312K 2312K 21312CCK 22312K	H 312 H 2312 H 312 H 2312	2 FRB 130/12.5 2 FRB 130/5 2 FRB 130/12.5 2 FRB 130/5	8X6.5-105/4	66.5
60	62	72	5	6.8	1313K 2313K 21313CCK 22313K	H 313 H 2313 H 313 H 2313	2 FRB 140/12.5 2 FRB 140/5 2 FRB 140/12.5 2 FRB 140/5	8X6.5-115/4	71.5
60	62	72	5	6.8	1314K 2314K 21314CCK 22314K	H 314 H 2314 H 314 H 2314	2 FRB 150/13 2 FRB 150/5 2 FRB 150/13 2 FRB 150/5	8X6.5-120 / 4	71.5
65	67	77	5	6.8	1315K 2315K 21315CCK 22315K	H 315 H 2315 H 315 H 2315	2 FRB 160/14 2 FRB 160/5 2 FRB 160/14 2 FRB 160/5	9X7.5-130 / 4	76.5
70	72	82	6	8.1	1316K 2316K 21316CCK 22316K	H 316 H 2316 H 316 H 2316	2 FRB 170/14.5 2 FRB 170/5 2 FRB 170/14.5 2 FRB 170/5	9X7.5-140 / 4	81.5
75	77	87	6	8.1	1317K 2317K 21317CCK 22317K	H 317 H 2317 H 317 H 2317	2 FRB 180/14.5 2 FRB 180/5 2 FRB 180/14.5 2 FRB 180/5	9X7.5-150 / 4	86.5
80	82	92	6	8.1	1318K 2318K 21318CCK 22318K	H 318 H 2318 H 318 H 2318	2 FRB 190/15.5 2 FRB 190/6.5 2 FRB 190/15.5 2 FRB 190/6.5	9X7.5-155 / 4	91.5
85	87	97	6	8.1	1319K 2319K 21319CCK 22319K	H 319 H 2319 H 319 H 2319	2 FRB 200/17.5 2 FRB 200/6.5 2 FRB 200/17.5 2 FRB 200/6.5	10X8.5-165/4	96.5
90	92	102	6	9.3	1320K 2320K 21320CCK 22320K	H 320 H 2320 H 320 H 2320	2 FRB 215/19.5 2 FRB 215/6.5 2 FRB 215/19.5 2 FRB 215/6.5	12X10-185/4	101.5
100	102	112	6	10.8	1322K 2322K 21322K 22322K	H 322 H 322 H 322 H 2322	2 FRB 240/20 2 FRB 240/5 2 FRB 240/20 2 FRB 240/5	12X10-200/4	111.5
110	112	122	6	10.7	22324K	H 2324	2 FRB 260/6	12X10-200/4	121.5
115	118	128	6	10.7	22326K	H 2326	2 FRB 280/6.5	14X11-245/4	127.5
125	128	138	6	12.2	22328K	H 2328	2 FRB 300/6	16X12-260/4	137.5
135	138	148	6	12.2	22330K	H 2330	2 FRB 320/5	16X12-260/4	147.5
140	143	153	6	13.7	22332K	H 2332	2 FRB 340/5	16X12-260/4	152.5

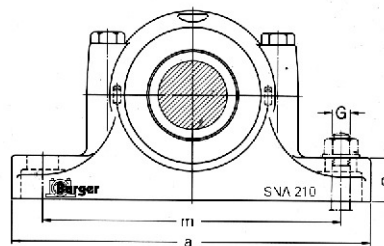
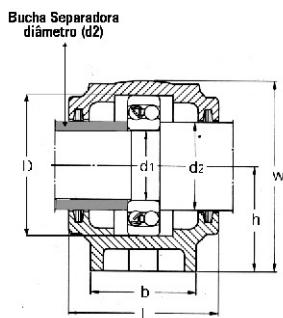
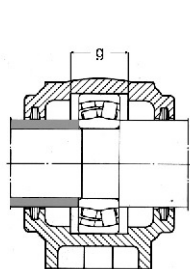

CAIXA	d1 eixo	d2	D H7	a	b	c	g H12	h H12	L	w	m	S	u	v
SNA 205	25	30	52	165	46	19	25	40	67	74	130	M 12	15	20
SNA 206	30	35	62	185	52	22	32	50	77	90	150	M 12	15	20
SNA 207	35	45	72	185	52	22	34	50	82	95	150	M 12	15	20
SNA 208	40	50	80	205	60	25	39	60	85	110	170	M 12	15	20
SNA 209	45	55	85	205	60	25	30	60	85	110	170	M 12	15	20
SNA 210	50	60	90	205	60	25	41	60	90	115	170	M 12	15	20
SNA 211	55	65	100	255	70	28	44	70	95	130	210	M 16	18	23
SNA 212	60	70	110	255	70	30	48	70	105	135	210	M 16	18	23
SNA 213	65	75	120	275	80	30	51	80	110	150	230	M 16	18	23
SNA 214	70	80	125	275	80	30	51	80	115	155	230	M 16	18	23
SNA 215	75	85	130	280	80	30	56	80	115	155	230	M 16	18	23
SNA 216	80	90	140	315	90	32	58	95	120	175	260	M 20	22	27
SNA 217	85	95	150	320	90	32	61	95	125	185	260	M 20	22	27
SNA 218	90	100	160	345	100	35	65	100	140	195	290	M 20	22	27
SNA 219	95	110	170	345	100	35	68	112	145	210	290	M 20	22	27
SNA 220	100	115	180	380	110	40	70	112	160	215	320	M 24	26	32
SNA 222	110	125	200	410	120	45	80	125	175	240	350	M 24	26	32
SNA 224	120	135	215	410	120	45	86	140	185	271	350	M 24	26	32
SNA 226	130	145	230	445	130	50	90	150	190	290	380	M 24	28	35
SNA 228	140	155	250	500	150	50	98	150	205	302	420	M 30	35	42
SNA 230	150	165	270	530	160	60	106	160	220	323	450	M 30	35	42
SNA 232	160	175	290	550	160	60	114	170	235	344	470	M 30	35	42

Obs: Os anéis de guia (FRB) e tampas A x DK, são fornecidas separadamente. Os bicos graxeiros serão colocados quando solicitados pelo cliente. A bucha separadora do diâmetro D1 não será fornecida.

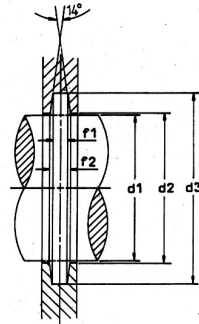

d1 H12	d2 H12	d3 H12	f1 H13	f2	ROLAMENTOS	ANÉIS DE BLOQUEIO	FELTROS	A-DK
25	26	36	5	5.4	1205 2205 22205	2 FRB 52/5 2 FRB 52/3.5 2 FRB 52/3.5	6X5-65 / 4	35.5
30	31	41	5	5.4	1206 2206 22206	2 FRB 62/8 2 FRB 62/6 2 FRB 62/6	6X5-70 / 4	40.5
35	36	46	5	5.4	1207 2207 22207	2 FRB 72/8.5 2 FRB 72/5.5 2 FRB 72/5.5	6X5-85 / 4	45.5
40	41	51	5	5.4	1208 2208 22208	2 FRB 80/10.5 2 FRB 80/8 2 FRB 80/8	8X6.5-100 / 4	50.5
45	46	56	5	5.4	1209 2209 22209	2 FRB 85/5.5 2 FRB 85/3.5 2 FRB 85/3.5	8X6.5-105 / 4	55.5
50	51	61	5	5.4	1210 2210 22210	2 FRB 90/10.5 2 FRB 90/9 2 FRB 90/9	8X6.5-115 / 4	60.5
55	57	67	5	6.9	1211 2211 22211	2 FRB 100/11.5 2 FRB 100/9.5 2 FRB 100/9.5	8X6.5-120 / 4	66.5
60	62	72	5	6.9	1212 2212 22212	2 FRB 110/13 2 FRB 110/10 2 FRB 110/10	9X7.5-130 / 4	71.5
65	67	77	5	6.9	1213 2213 22213	2 FRB 120/14 2 FRB 120/10 2 FRB 120/10	9X7.5-140 / 4	76.5
70	72	82	5	6.9	1214 2214 22214	2 FRB 125/10 2 FRB 125/6.5 2 FRB 125/6.5	9X7.5-150 / 4	81.5
75	77	87	5	6.9	1215 2215 22215	2 FRB 130/15.5 2 FRB 130/12.5 2 FRB 130/12.5	9X7.5-155 / 4	86.5
80	82	92	6	8.1	1216 2216 22216	2 FRB 140/16 2 FRB 140/12.5 2 FRB 140/12.5	10X8.5-165 / 4	91.5
85	87	97	6	8.1	1217 2217 22217	2 FRB 150/16.5 2 FRB 150/12.5 2 FRB 150/12.5	10X8.5-175 / 4	96.5
90	92	102	6	8.1	1218 2218 22218 23218	2 FRB 160/17.5 2 FRB 160/12.5 2 FRB 160/12.5 2 FRB 160/6.25	12X10-185 / 4	101.5
95	97	107	6	8.1	1219 2219 22219	2 FRB 170/18.5 2 FRB 170/12.5 2 FRB 170/12.5	12X10-200 / 4	106.5
100	102	112	6	8.1	1220 2220 22220 23220	2 FRB 180/18 2 FRB 180/12 2 FRB 180/12 2 FRB 180/4.85	12X10-210 / 4	111.5
110	112	122	6	10.8	1222 2222 22222 23222	2 FRB 200/21 2 FRB 200/13.5 2 FRB 200/13.5 2 FRB 200/5.1	14X11-230 / 4	121.5
120	122	132	6	10.8	22224 23224	2 FRB 215/14 2 FRB 215/5	14X11-245 / 4	131.5
130	133	143	6	10.8	22226 23226	2 FRB 230/13 2 FRB 230/5	16X12-265 / 4	142.5
140	143	153	6	12.2	22228 23228	2 FRB 250/15 2 FRB 250/5	16X12-265 / 4	152.5
150	153	163	6	12.2	22230 23230	2 FRB 270/16.5 2 FRB 270/5	16X12-300 / 4	162.5
160	163	173	6	13.7	22232 23232	2 FRB 290/17 2 FRB 290/5	16X12-315 / 4	172.5

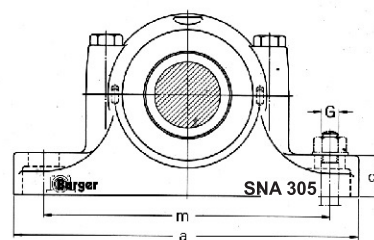
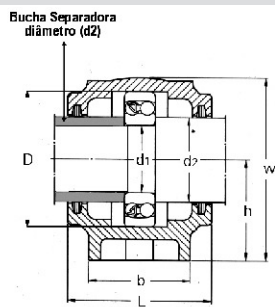
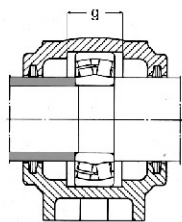

CAIXA	Eixo		D H7	a	b	c	g H12	h H12	L	w	m	S	u	v
	d1	d2												
SNA 305	25	30	62	185	52	22	32	50	77	90	150	M 12	15	20
SNA 306	30	35	72	185	52	22	34	50	82	95	150	M 12	15	20
SNA 307	35	45	80	205	60	25	39	60	85	110	170	M 12	15	20
SNA 308	40	50	90	205	60	25	41	60	90	115	170	M 12	15	20
SNA 309	45	55	100	255	70	28	44	70	95	130	210	M 16	18	23
SNA 310	50	60	110	255	70	30	48	70	105	135	210	M 16	18	23
SNA 311	55	65	120	275	80	30	51	80	110	150	230	M 16	18	23
SNA 312	60	70	130	280	80	30	56	80	115	155	230	M 16	18	23
SNA 313	65	75	140	315	90	32	58	95	120	175	260	M 20	22	27
SNA 314	70	80	150	320	90	32	61	95	125	185	260	M 20	22	27
SNA 315	75	85	160	345	100	35	65	100	140	195	290	M 20	22	27
SNA 316	80	90	170	345	100	35	68	112	145	210	290	M 20	22	27
SNA 317	85	95	180	380	110	40	70	112	160	215	320	M 24	26	32
SNA 318	90	105	190	380	110	40	74	112	160	220	320	M 24	26	32
SNA 319	95	110	200	410	120	45	80	125	175	240	350	M 24	26	32
SNA 320	100	115	215	410	120	45	86	140	185	271	350	M 24	26	32
SNA 322	110	125	240	450	130	50	90	150	185	298	390	M 24	28	35
SNA 324	120	135	260	530	160	60	98	160	190	321	450	M 30	35	42
SNA 326	130	150	280	550	160	60	106	170	205	344	470	M 30	35	42
SNA 328	140	160	300	620	170	65	114	180	215	366	520	M 30	35	42
SNA 330	150	170	320	650	180	65	118	190	225	386	560	M 30	35	42
SNA 332	160	180	340	680	190	70	124	200	235	406	580	M 36	42	50

Obs: Os anéis de guia (FRB) e tampas A x DK, são fornecidas separadamente. Os bicos graxeiros serão colocados quando solicitados pelo cliente. A bucha separadora do diâmetro D1 não será fornecida.

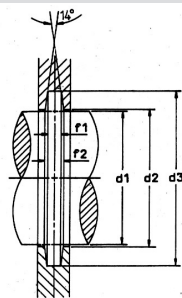

d1 H12	d2 H12	d3 H12	f1 H13	f2	ROLAMENTOS	ANÉIS DE BLOQUEIO	FELTROS	A-DK
25	31	41	5	5.4	1305 2305 21305	2 FRB 62/7.5 2 FRB 62/4 2 FRB 62/7.5	6X5-60 / 4	40.5
30	36	46	5	5.4	1306 2306 21306	2 FRB 72/7.5 2 FRB 72/3.5 2 FRB 72/7.5	6X5-70 / 4	45.5
35	46	56	5	5.4	1307 2307 21307	2 FRB 80/9 2 FRB 80/4 2 FRB 80/9	6X5-85 / 4	55.5
40	51	61	5	5.4	1308 2308 21308 22308	2 FRB 90/9 2 FRB 90/4 2 FRB 90/9 2 FRB 90/4	8X6.5-105 / 4	60.5
45	56	66	5	5.4	1309 2309 21309 22309	2 FRB 100/9.5 2 FRB 100/4 2 FRB 100/9.5 2 FRB 100/4	8X6.5-105 / 4	65.5
50	61	71	5	5.4	1310 2310 21310 22310	2 FRB 110/10.5 2 FRB 110/4 2 FRB 110/10.5 2 FRB 110/4	8X6.5-115 / 4	70.5
55	66	76	5	6.9	1311 2311 21311 22311	2 FRB 120/11 2 FRB 120/4 2 FRB 120/11 2 FRB 120/4	8X6.5-120 / 4	75.5
60	71	81	5	6.9	1312 2312 21312 22312	2 FRB 130/12.5 2 FRB 130/5 2 FRB 130/12.5 2 FRB 130/5	8X7.5-130 / 4	80.5
65	76	86	5	6.9	1313 2313 21313 22313	2 FRB 140/12.5 2 FRB 140/5 2 FRB 140/12.5 2 FRB 140/5	9X7.5-140 / 4	85.5
70	81	91	5	6.9	1314 2314 21314 22314	2 FRB 150/13 2 FRB 150/5 2 FRB 150/13 2 FRB 150/5	9X7.5-150 / 4	90.5
75	87	97	5	6.9	1315 2315 21315 22315	2 FRB 160/14 2 FRB 160/5 2 FRB 160/14 2 FRB 160/5	9X7.5-155 / 4	96.5
80	92	102	6	8.1	1316 2316 21316 22316	2 FRB 170/14.5 2 FRB 170/5 2 FRB 170/14.5 2 FRB 170/5	10X8.5-165 / 4	101.5
85	97	107	6	8.1	1317 2317 21317 22317	2 FRB 180/14.5 2 FRB 180/5 2 FRB 180/14.5 2 FRB 180/5	10X8.5-175 / 4	106.5
90	107	117	6	8.1	1318 2318 21318 22318	2 FRB 190/15.5 2 FRB 190/5 2 FRB 190/15.5 2 FRB 190/5	12X12-195 / 4	116.5
95	112	122	6	8.1	1319 2319 21319 22319	2 FRB 200/17.5 2 FRB 200/6.5 2 FRB 200/17.5 2 FRB 200/6.5	12X10-200 / 4	121.5
100	117	127	6	10.8	1320 2320 21320 22320	2 FRB 215/19.5 2 FRB 215/6.5 2 FRB 215/19.5 2 FRB 215/6.5	12X10-210 / 4	126.5
110	127	137	6	10.8	20322 21322 22322	2 FRB 240/20 2 FRB 240/20 2 FRB 240/5	14X11-230 / 4	136.5
120	138	148	6	10.8	20324 22324	2 FRB 260/20.5 2 FRB 260/6	14X11-245 / 4	147.5
130	153	163	6	10.8	20326 22326	2 FRB 280/22.5 2 FRB 280/6.5	16X12-275 / 4	162.5
140	163	173	6	12.2	20328 22328	2 FRB 300/25 2 FRB 300/6	16X12-290 / 4	172.5
150	173	183	6	12.2	20330 22330	2 FRB 320/26.5 2 FRB 320/5	16X12-305 / 4	182.5
160	183	193	6	12.2	20332 22332	2 FRB 340/28 2 FRB 340/5	16X12-320 / 4	192.5