

Rolament Fixo
BND...AF

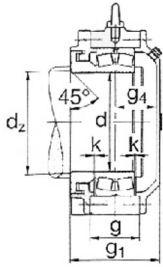

Tipo A

Rolamento Fixo
BND...BF

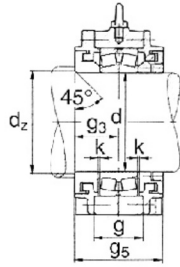

Tipo B

Rolamento Fixo
BND...TAF

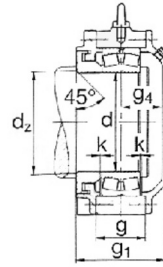

Tipo A

Rolamento Fixo
BND...TBF

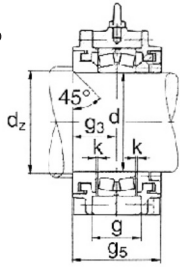

Tipo B

Rolament Livre
BND...AL

Rolamento Livre
BND...BL

Rolamento Livre
BND...TAL

Rolamento Livre
BND...TBL

Caixa	Rolam.	Buc. Fix.	d	d1	a	b	c	dc	dz	g	g1	g2	g3	g4	g5	h	h1	k	m	n	u	v	s	t	s2	Qtde.
BND 2213	22213	H 313	65	60	235	70	22	66	71	44	100	120	55	39	110	80	155	2	185	40	15	20	M10	135	M6	6
BND 2215	22215	H 315	75	65	285	85	35	71	81	45	105	125	55	44	110	90	180	2	225	45	20	28	M16	155	M6	6
BND 2218	22218	H 318	90	80	370	110	38	88	98	55	104	123	53	45	106	110	220	2	290	60	23	32	M20	185	M8	6
BND 2220	22220	H 320	100	90	400	120	40	98	108	65	141	168	78	57	156	130	255	2.5	320	65	30	35	M24	205	M8	6
BND 2222	22222	H 322	110	100	440	130	42	108	118	73	149.2	172	82.6	60	165.2	140	280	2.5	350	70	30	35	M24	230	M12	6
BND 3122	23122	H 3122		100	400	140	40	108	118	80	146	171	78	62	156	130	263	2.5	300	80	25	35	M20	215	M12	8
BND 3222	23222	H 2322		100	440	130	42	108	118	89.8	166	194	91	68	182	140	280	2.5	350	70	30	35	M24	230	M12	6
BND 2224	22224	H 3124	120	110	470	140	42	118	128	77	143	168	74	61	148	150	300	2.5	370	75	30	35	M24	245	M12	6
BND 3024	23024	H 3024		110	370	110	35	118	128	60	126	146	63	57	126	115	230	2.5	300	60	25	35	M20	205	M8	8
BND 3124	23124	H 3124		110	410	150	40	118	128	85	160	180	80	74	160	140	280	2.5	330	80	25	35	M20	235	M12	8
BND 3224	23224	H 2324		110	470	140	42	118	128	95	161	186	83	70	166	150	300	2.5	370	75	30	35	M24	245	M12	6
BND 2226	22226	H 3126	130	115	500	150	45	127	142	84	172	202	95	69	190	160	315	3	400	85	30	35	M24	260	M12	6
BND 3026	23026	H 3026		115	410	120	38	123	138	70	133	156	68	59	136	130	260	2	340	60	25	35	M20	225	M10	8
BND 3126	23126	H 3126		115	430	150	40	123	138	90	165	190	85	72	170	145	295	3	350	80	25	35	M20	245	M12	8
BND 3226	23226	H 2326		115	500	150	45	127	142	100	188	218	103	77	206	160	315	3	400	85	30	35	M24	260	M12	6
BND 2228	22228	H 3128	140	125	530	160	50	137	152	88	166	196	88	70	176	170	345	3	430	85	30	35	M24	285	M16	6
BND 3028	23028	H 3028		125	430	130	40	133	148	70	136	156	68	61	136	140	275	3	360	70	30	35	M24	240	M10	8
BND 3128	23128	H 3128		125	470	160	45	133	148	95	170	190	85	77	170	155	315	3	380	85	25	35	M20	270	M12	8
BND 3228	23228	H 2328		125	530	160	50	137	152	108	186	216	98	80	196	170	345	3	430	85	30	35	M24	285	M16	6
BND 2230	22230	H 3130	150	135	550	170	54	147	162	97	177	202	93.5	76	187	180	365	3	450	90	36	45	M30	305	M16	6
BND 3030	23030	H 3030		135	455	140	42	143	158	80	149	176	78	64	156	145	290	2	370	80	30	35	M24	250	M12	8
BND 3130	23130	H 3130		135	580	200	60	143	158	102	186	206	93	85	186	170	345	2	450	110	30	35	M24	285	M12	8
BND 3230	23230	H 2330		135	550	170	54	147	162	120	200	225	105	87	210	180	365	3	450	90	36	45	M30	305	M16	6
BND 2232	22232	H 3132	160	140	600	180	58	152	172	106	189	226	103	78	206	190	385	3	490	105	36	45	M30	330	M16	6
BND 3032	23032	H 3032		140	480	150	45	148	168	85	156	181	78	71	156	155	310	3	390	90	30	35	M24	265	M12	8
BND 3132	23132	H 3132		140	540	200	55	148	168	110	200	230	105	87	210	180	360	3	430	110	30	35	M24	310	M16	6
BND 3232	23232	H 2332		140	600	180	58	152	172	130	213	250	115	90	230	190	385	3	490	105	36	45	M30	330	M16	6
BND 2234	22234	H 3134	170	150	640	200	62	166	186	111	216	256	118	88	236	200	405	3	525	110	36	45	M30	350	M16	8
BND 3034	23034	H 3034		150	510	160	50	158	178	90	166	191	83	75	166	165	330	2	420	95	36	45	M30	285	M12	8
BND 3134	23134	H 3134		150	570	200	55	158	178	120	215	250	115	90	230	190	380	3	470	110	36	45	M30	330	M12	8
BND 3234	23234	H 2334		150	640	200	62	166	186	135	240	280	130	100	260	200	405	3	525	110	36	45	M30	350	M16	8
BND 2236	22236	H 3136	180	160	680	210	65	176	196	112	214	248	114	92	228	210	425	3	550	120	36	45	M30	370	M16	8
BND 3036	23036	H 3036		160	540	170	52	168	188	100	176	201	88	80	176	180	360	3	450	100	36	45	M30	310	M12	8
BND 3136	23136	H 3136		160	600	200	58	172	192	125	220	250	115	95	230	200	395	3	490	105	36	45	M30	350	M16	8
BND 3236	23236	H 2336		160	680	210	65	176	196	138	240	274	127	105	254	210	425	3	550	120	36	45	M30	370	M16	8
BND 2238	22238	H 3138	190	170	710	220	85	186	206	115	222	258	114	98	228	220	455	3	560	120	42	52	M36	380	M16	8
BND 3038	23038	H 3038		170	570	180	55	178	198	105	181	211	93	80	186	185	370	3	480	105	36	45	M30	325	M12	8
BND 3138	23138	H 3138		170	680	210	65	182	202	130	232	266	123	98	246	210	425	3	550	120	36	45	M30	370	M16	8
BND 3238	23238	H 2338		170	710	220	85	186	206	143	250	286	128	112	256	220	455	3	560	120	42	52	M36	380	M16	8
BND 2240	22240	H 3140	200	180	780	240	75	196	216	128	230	269	123	99	246	235	475	4	640	140	42	52	M36	420	M16	8
BND 3040	23040	H 3040		180	600	190	60	188	208	110	196	226	98	90	196	200	400	3	510	110	36	45	M30	340	M16	8
BND 3140	23140	H 3140		180	710	220	85	192	212	135	242	278	124	108	248	220	455	3	560	120	42	52	M36	380	M16	8
BND 3240	23240	H 2340		180	780	240	75	196	216	158	260	299	138	114	276	235	475	4	640	140	42	52	M36	420	M16	8

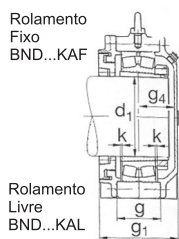
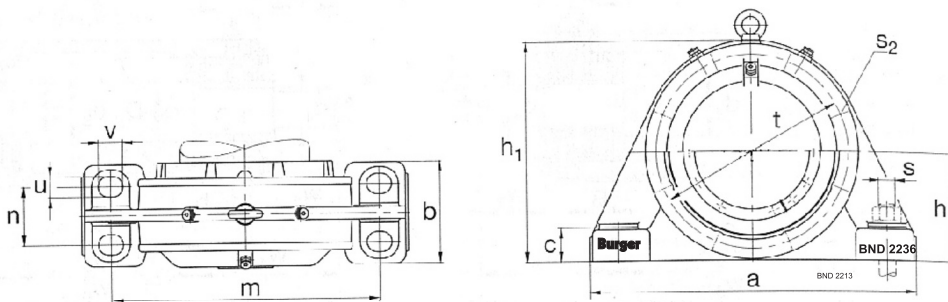

Tipo A

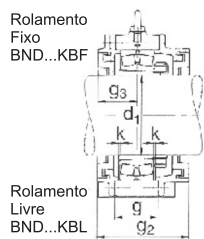

Tipo B

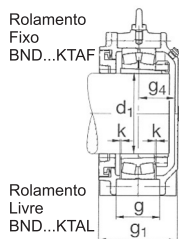

Tipo A

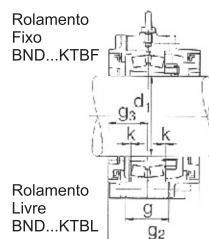

Tipo B

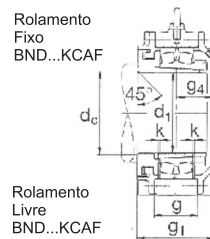

Tipo A

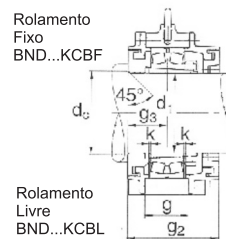

Tipo B

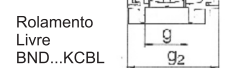
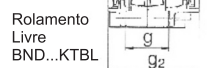
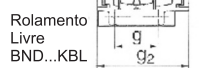

Caixa	Rolam.	Buc. Fix.	d	d1	a	b	c	dc	dz	g	g1	g2	g3	g4	g5	h	h1	k	m	n	u	v	s	t	s2	Qtde.
BND 2244	22244	H 3144X	220	200	890	250	80	216	236	140	264	314	142	112	284	270	550	4	720	140	42	52	M36	455	M20	8
BND 3044	23044	H 3044X		200	640	200	65	212	232	115	206	241	103	95	206	215	430	3	540	115	42	52	M36	375	M16	8
BND 3144	23144	H 3144X		200	780	240	75	216	236	150	252	291	134	110	268	235	475	4	640	140	42	52	M36	420	M16	8
BND 3244	23244	H 2344X		200	850	250	80	216	236	175	279	329	147	122	294	260	525	4	700	140	42	52	M36	445	M20	8
BND 2248	22248	H 3148X	240	220	900	250	90	236	256	150	268	311	138	120	276	290	585	4	750	140	42	52	M36	510	M20	8
BND 3048	23048	H 3048		220	680	210	70	232	252	120	216	251	108	100	216	225	455	4	560	120	42	52	M36	400	M16	8
BND 3148	23148	H 3148X		220	890	250	80	236	256	160	284	334	152	122	304	270	550	4	720	140	42	52	M36	455	M20	8
BND 3248	23248	H 2348X		220	900	250	90	236	256	190	308	351	158	140	316	290	585	4	750	140	42	52	M36	510	M20	8
BND 2252	22252	H 3152X	260	240	960	290	95	260	280	161	286	326	148	126	296	310	625	3	800	160	42	52	M36	535	M20	8
BND 3052	23052	H 3052X		240	720	220	75	256	276	130	226	261	113	103	226	250	500	4	600	130	42	52	M36	440	M16	8
BND 3152	23152	H 3152X		240	900	250	90	256	276	174	292	335	150	132	300	290	585	4	750	140	42	52	M36	510	M20	8
BND 3252	23252	H 2352X		240	960	290	95	260	280	205	330	370	170	148	340	310	625	3	800	160	42	52	M36	535	M20	8
BND 2256	22256	H 3156X	280	260	1000	300	100	280	300	160	297	354	157	128	314	320	645	4	840	170	42	52	M36	555	M24	8
BND 3056	23056	H 3056		260	760	240	80	276	296	135	236	281	118	108	236	260	520	4	630	140	42	52	M36	460	M16	8
BND 3156	23156	H 3156X		260	900	250	90	280	300	176	294	337	151	133	302	290	585	4	750	140	42	52	M36	510	M20	8
BND 3256	23256	H 2356X		260	1000	300	100	280	300	206	343	400	180	151	360	320	645	4	840	170	42	52	M36	555	M24	8
BND 2260	22260	H 3160	300	280	1100	330	105	300	320	178	317	352	156	149	312	350	695	4	920	180	56	75	M48	600	M24	8
BND 3060	23060	H 3060		280	820	250	85	296	316	140	261	296	128	121	256	285	570	4	690	150	42	52	M36	510	M16	8
BND 3160	23160	H 3160		280	1000	300	100	300	320	190	327	384	172	143	344	320	645	4	840	170	42	52	M36	555	M24	8
BND 3260	23260	H 3260		280	1100	330	105	300	320	230	369	404	182	175	364	350	705	4	920	180	56	75	M48	600	M24	8
BND 2264	22264	H 3164	320	300	1150	360	115	320	340	180	333	381	163	158	326	370	745	5	960	200	56	75	M48	640	M24	8
BND 3064	23064	H 3064		300	860	260	90	316	336	150	266	311	133	123	266	295	590	4	730	160	42	52	M36	530	M16	8
BND 3164	23164	H 3164		300	1150	300	100	320	340	210	359	412	186	161	372	350	700	4	940	160	42	52	M36	590	M24	8
BND 3264	23264	H 3264		300	1150	360	115	320	340	238	391	439	192	187	384	370	745	5	960	200	56	75	M48	640	M24	8
BND 2268	22268	H 3168	340	320	1200	380	125	344	364	201	375	430	187.5	176	375	390	790	5	990	200	64	85	M56	680	M30	8
BND 3068	23068	H 3068		320	900	270	95	340	360	160	276	311	133	132	266	315	630	5	770	170	42	52	M36	565	M20	8
BND 3168	23168	H 3168		320	1150	360	115	340	360	220	373	421	183	178	366	370	745	5	960	200	56	75	M48	640	M24	8
BND 3268	23264	H 3268		320	1200	380	125	344	364	260	434	489	217	205	434	390	790	5	990	200	64	85	M56	680	M30	8
BND 2272	22272	H 3172	360	340	1280	400	130	364	384	205	375	435	185	178	370	410	820	5	1040	210	72	90	M64	710	M30	8
BND 3072	23072	H 3072		340	960	280	100	360	380	170	290	325	140	138	280	330	660	5	820	180	42	52	M36	590	M20	8
BND 3172	23172	H 3172		340	1200	370	115	360	380	225	400	450	200	188	400	380	760	4	1000	200	56	75	M48	650	M24	8
BND 3272	23272	H 3272		340	1280	400	130	364	384	267	437	497	216	209	432	410	820	5	1040	210	72	90	M64	710	M30	8
BND 2276	22276	H 3176	380	360	1350	405	135	384	404	230	433	470	203	218	406	425	865	5	1100	225	72	90	M64	745	M30	8
BND 3076	23076	H 3076		360	1000	300	105	380	400	160	294	329	142	141	284	340	680	7	840	190	56	75	M48	610	M20	8
BND 3176	23176	H 3176		360	1200	380	125	380	400	230	404	459	202	190	404	390	790	5	1000	200	64	85	M56	680	M30	8
BND 3276	23276	H 3276		360	1350	405	135	384	404	295	489	529	232	244	464	425	860	5	1100	225	72	90	M64	745	M30	8
BND 2280	22280	H 3180	400	380	1430	450	145	404	424	229	433	498	216.5	202	433	450	900	5	1160	240	72	90	M64	790	M30	8
BND 3080	23080	H 3080		380	1060	320	110	400	420	175	310	355	150	145	300	360	720	7	900	200	56	75	M48	650	M20	8
BND 3180	23180	H 3180		380	1280	400	130	404	424	235	405	465	200	193	400	410	820	5	1040	210	72	90	M64	710	M30	8
BND 3280	23280	H 3280		380	1430	450	145	404	424	300	504	569	252	237	504	450	900	5	1160	240	72	90	M64	790	M30	8
BND 2284	22284	H 3184	420	400	1500	470	150	430	450	238	433	498	216.5	202	433	470	950	5	1220	255	72	90	M64	835	M30	8
BND 3084	23084	H 3084		400	1100	340	115	420	440	180	310	350	150	149	300	375	755	7	940	210	56	75	M48	670	M20	8
BND 3184	23184	H 3184		400	1350	420	135	424	444	260	440	510	210	215	420	450	900	7	1100	210	64	85	M56	760	M30	8
BND 3284	23284	H 3284		400	1500	470	150	430	450	315	510	575	255	240	510	470	950	5	1220	255	72	90	M64	835	M30	8